

Consoles pour tablettes EUROPA

Indication pour la commande: page suivante

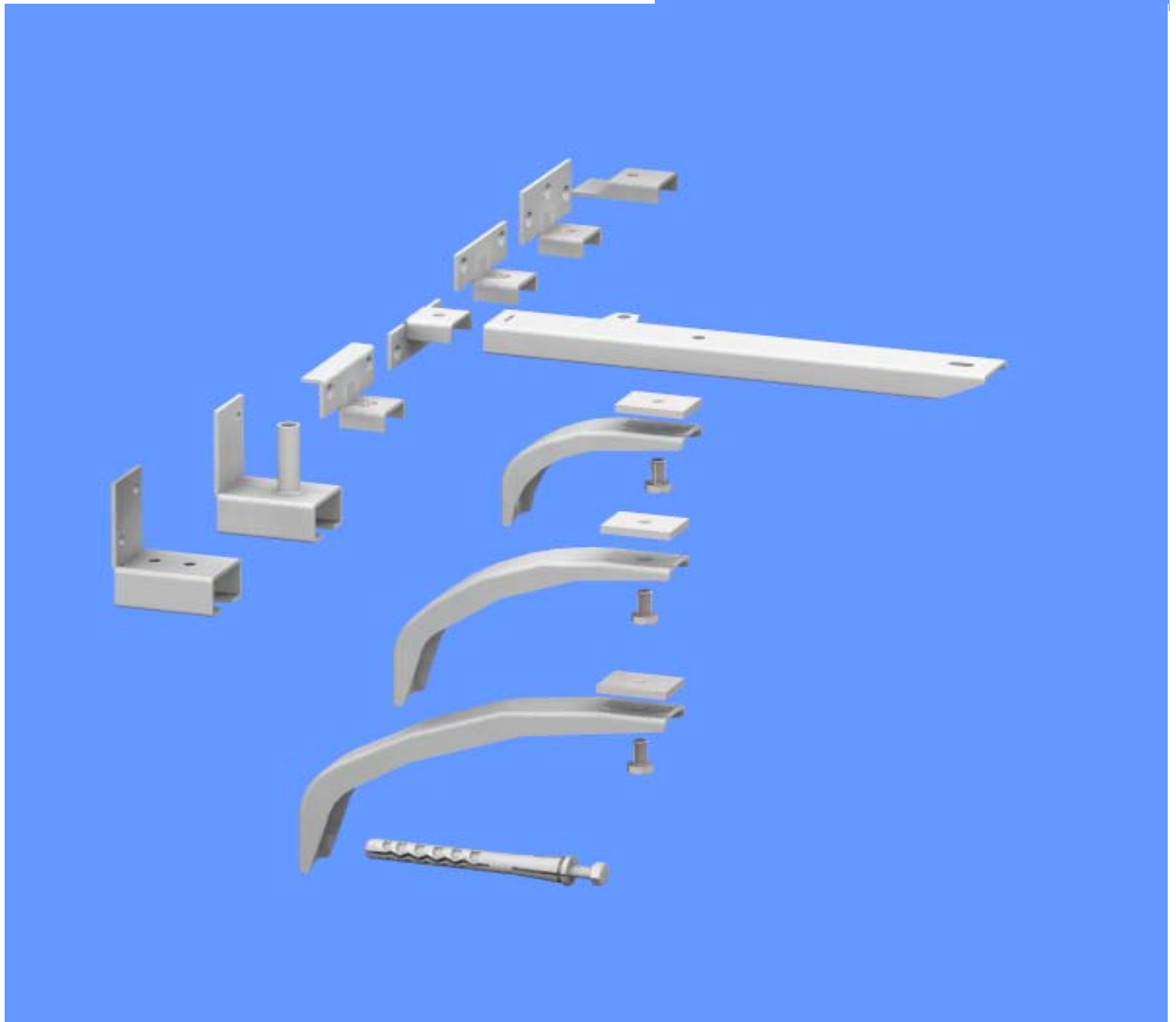

Système de construction par blocs éprouvé
Avec plus de 150 combinaisons possible

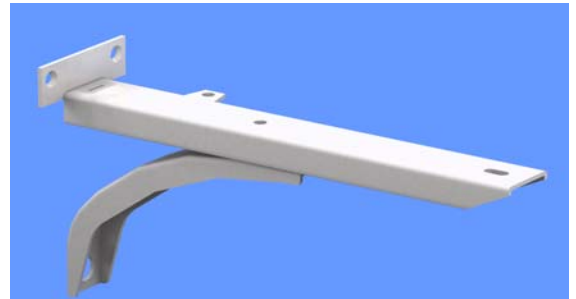

KONSOLEN AG

Hauptstrasse 30

Telefon +41 61 935 20 20

CH-4417 ZIEFEN

Telefax +41 61 935 20 21

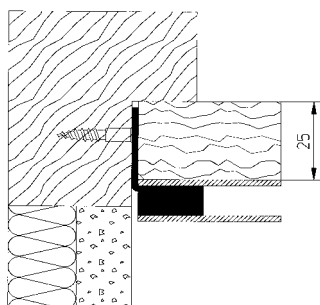

Art.69

Fixation en haut

No de cde

69

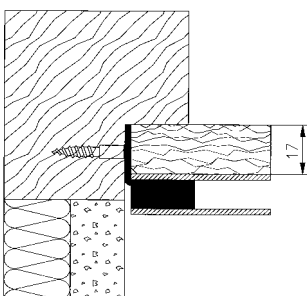

Art.71

Fixation en haut

No de cde

71

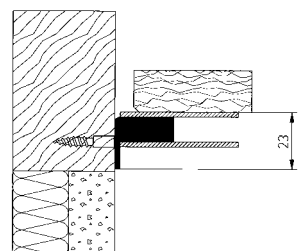
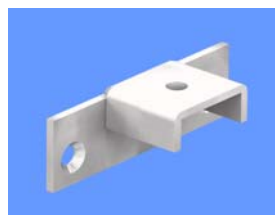

Art.72

Fixation en bas

No de cde

72

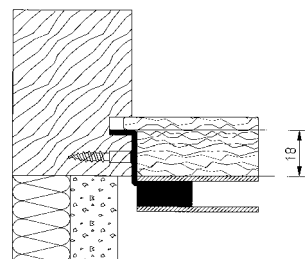

Art.73

Fixation pour châssis avec rainure

No de cde

73

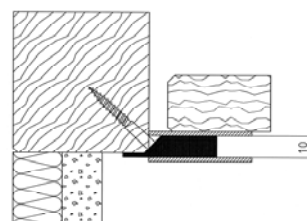
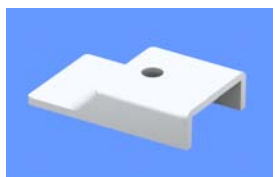

Art.74

Fixation à languette

No de cde

74

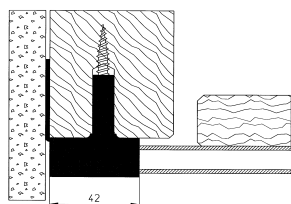

Art.76

Fixation pour support Europa y.c.
vis à tête conique 6x60 mm

No de cde

76

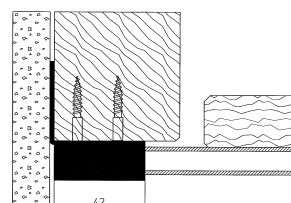

Art.77

Fixation pour support Europa

No de cde

77

Art.70

Support de tablettes en profil C
28x15mm avec patte latérale

longueur
mm

No de cde

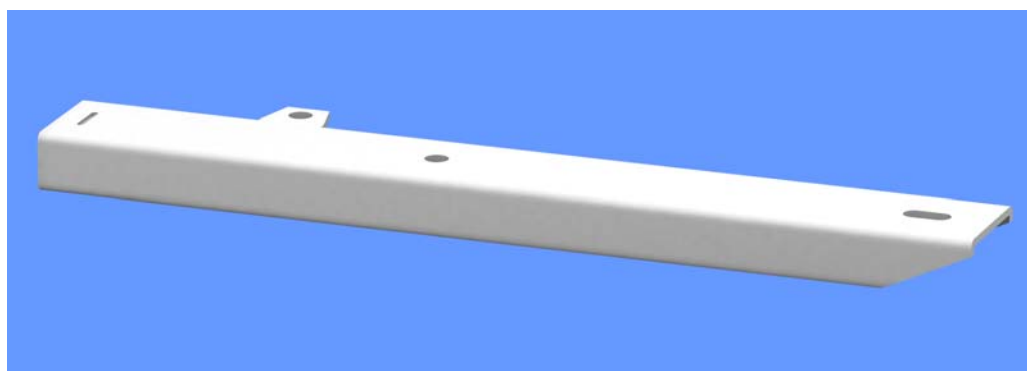

60	70/060
80	70/080
100	70/100
120	70/120
140	70/140
170	70/170
200	70/200
220	70/220
270	70/270
320	70/320

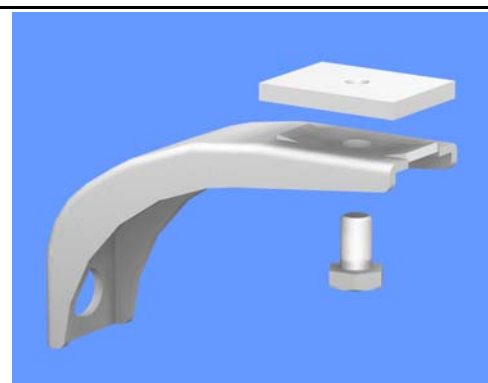

Art.78

Appui pour consoles Europa
complète avec vis-pans et
plaque à vis filetée

L x H
mm

No de cde

80 x 55	78/080
120 x 85	78/120
160 x 100	78/160



KONSOLEN AG

Hauptstrasse 30

Telefon +41 61 935 20 20

CH-4417 ZIEFEN

Telefax +41 61 935 20 21



Art.319/9

Tampon Ø 10 mm complet avec vis à bois, tête hexagonale coulissant sur Art.78/1-3

Longeur	No. de cde.
90mm	319/9

Exemple de montage

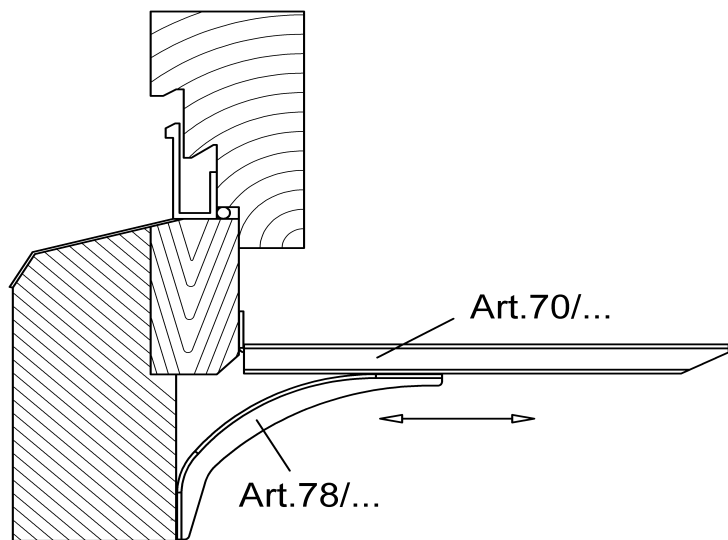

Contre-cœur en retrait

Appui est librement ajustable

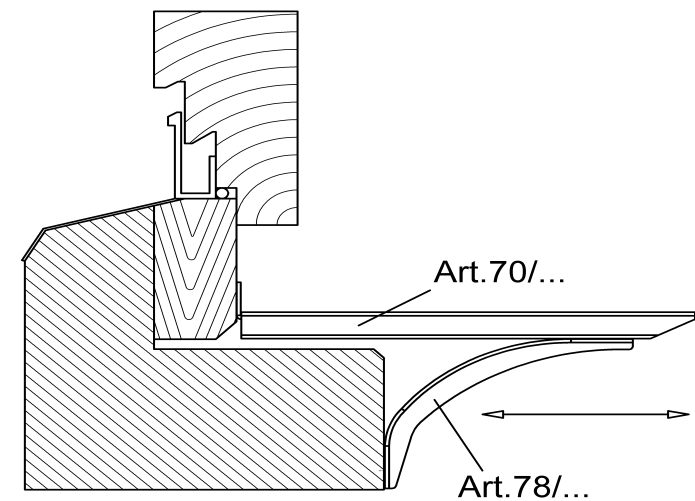

Contre-cœur en saillie

Appui est librement ajustable

Console rabattable



Art. 59

L = 250 mm 59 / 250
 L = 300 mm 59 / 300
 L = 350 mm 59 / 350

sans dispositif de blocage

Art. 59 / A

L = 250mm 59 / 250A
 L = 300mm 59 / 300A
 L = 350mm 59 / 350A

Avec dispositif de blocage

Charge admissible par console
 (repartition régulière de la charge)

L = 250mm 150 kg
 L = 300mm 125 kg
 L = 350mm 100 kg

Console rabattable en profilés U, avec soutien à enclenchement automatique. S'enclenche automatique lorsqu'on relève le support. Déclenchement en soulevant brièvement le dispositif de blocage, Exécution: Revêtu par poudrage couleur blanche



KONSOLEN AG

Hauptstrasse 30

Telefon +41 61 935 20 20

CH-4417 ZIEFEN

Telefax +41 61 935 20 21

